

Data Sheet



Article number: 2761831591121

Description: KLEEblower KB8315 11/13 kW
3x400/690V 50/60Hz double stage

Measures

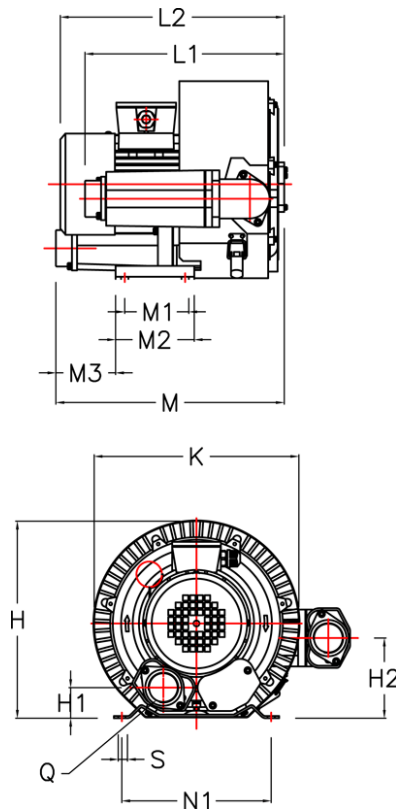

H = 567	M2 = 315
H1 = 96	M3 = 175
H2 = 199	N1 = 365
K = 486	Noise level dB 50/60Hz = 76/81
L1 = 497.5	Q = 2-PF 2 1/2" (NPT 2 1/2")
L2 = 623	S = 4 x Ø15
M = 618	
M1 = 280	